



**Local Microwave Protective Detector
Forteza FMC 10 (50m, 100m, 200m)**

**Description Manual & Service Instruction
No. 2021-01-21**



2021

CONTENTS

1.	DESCRIPTION AND OPERATION	3
1.1.	Purpose	3
1.2.	Specifications	3
1.3.	Sensor components.....	6
1.4.	Operation principle.....	6
1.5.	Sensor structure.....	7
1.6.	Adjustment, control and indication parts	9
2.	INSTALLATION AND ADJUSTMENT PROCEDURE.....	10
2.1.	Requirements for the protected sector and Rx and Tx arrangement	10
2.2.	TX and RX mounting.....	11
2.3.	Sensor connection	15
2.4.	Sensor adjustment with the build in adjustment control and indication parts	17
2.5.	Software installation and detector adjustment by means of PC or any ANDROID device (using RS-BL converter).....	19
2.5.6	ANDROID software installation.....	30
2.6.	Trial operation.....	32
2.7	Creation and saving of the report.....	32
3.	MAINTENANCE	32
3.1.	Performance check.....	32
3.2.	Maintenance check.....	32
3.3.	Safety measures.....	33
4.	TROUBLESHOOTING GUIDE	33
5.	STORAGE	35
6.	TRANSPORTATION.....	35
	Certificate.....	36

1. DESCRIPTION AND OPERATION

The present description manual and service instruction contains information about the operation of the local microwave protective detectors series FMC 10 (50m 100m 200m) below the detector. In this document there is information required for the correct operation (use, transportation, storage and maintenance) of the detector.

The following abbreviations are used in the present document:

Tx - transmitter

Rx - receiver.

MK - mounting kit;

1.1. Purpose

1.1.1. The purpose of the sensors is to protect the perimeter sectors and to detect an intruder crossing this sector at his “full height” or “bent”. An alarm is generated by breaking the individual point relay contacts. Then it is transmitted on the receiver.

1.1.2. The detector is intended for continuous round-the-clock outdoor operation at an ambient temperature $-40^{\circ}\text{C} \dots +60^{\circ}\text{C}$ and relative humidity up to 98% at the temperature $+35^{\circ}\text{C}$.

1.1.3. When the sensor operates with the alarm complex, you can control the sensor with RS-485 interface.

1.2. Specifications

1.2.1. The recommended length (L) of a sector for modifications:

FMC 10 (200m) – 10...200 m

FMC 10 (100m) – 10...100 m

FMC 10 (50m) – 5...50 m

The detection zone height, h:

FMC 10 (200m) 1,8 m* maximum

FMC 10 (100m) 1,6 m* maximum

FMC 10 (50m) 1,4 m* maximum

The detection zone width, b :

FMC 10 (200m) 4,0 m* maximum

FMC 10 (100m) 3.0 m* maximum

FMC 10 (50m) 2.0 m* maximum

** in the middle of a sector at the maximum length*

The cross speed: 0,1 up to 10 m/sec

The quantity of the frequency channels 4

Supply voltage	9...30 V
Current consumption	up to 16 mA
- Tx	5 mA
- Rx	11 mA
Individual point relay parameters:	
Switching voltage	30 V
Switching current	0,1 A
Alarm contact resistance	100 Ohms
“dead” zones	2...3 m
Readiness time	
switch ON	30 sec
switch OFF	1 sec
The parameters of TAMPER button:	
- voltage	30 V
- current consumption	0,1 A
Protection class	IP55

The configuration and the dimensions of the detection zone are given in fig. 1.1. and table 1.1

Table 1.1

Length of a sector, L , m	10	25	50	100	200
Detection zone width, b , m, max	0,8	1,0	2,0	3,0	4,0
Detection zone height, h , m, max	0,8	1,0	1,4	1,6	1,8

1.2.2. The detection zone is a volumetric part of a sector that being the very specialty in the kind of detection, and any movement within this sector will generate an alarm.

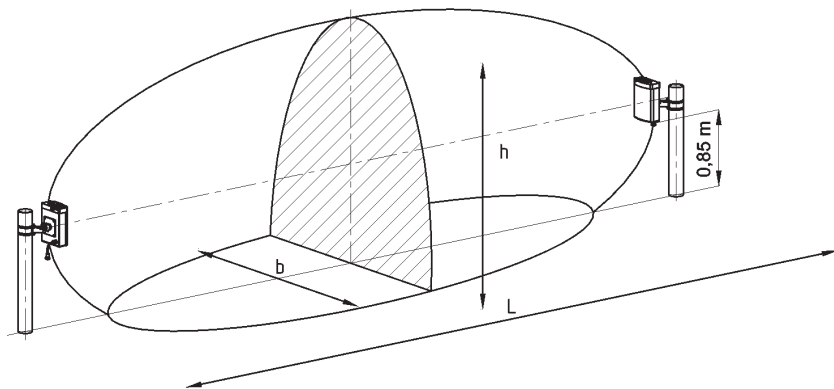

Fig.1.1. Detection zone

L- Length of a sector **h**- Height of detection zone **b**- Width of detection zone

1.2.3. In Fig.1.1 and Table 1.1 the height (h) and the width (b) of the detection zone are given for the middle of the sector. Moving towards the receiver or transmitter these dimensions decrease evenly, given the geometry of positioning the receiver and transmitter.

1.2.4. The recommended distance from the axis of the detection zone up to fences, building walls and other motionless objects at the sector length:

80...200m - 2, 0 m minimum

25...80m - 1, 5 m minimum

10...25m - 1, 0 m minimum

1.2.5. The sensor generates an alarm when:

- an intruder crosses the detection zone. Detection probability is 98 % when an intruder crosses the detection zone at his “full height” or “bent”;
- external electromagnetic field influences on Rx for its masking. There may be no alarm signal, but in this case the sensor should save its operability.

An alarm is generated by breaking the contacts of optoelectronic individual point relay (standby mode) for 3 sec minimum. Orange and brown wires marked «NC» (normally closed) and this alarm is transmitted over RS-485 interface.

Note. *At the distance of 2-3 m from the supports with Tx and Rx the probability of the intruder's detection, who is moving stooping down (crawling through) in the detection zone, is less than 98 % as an intruder can stoop down and pass below the detection zone.*

1.2.6. The sensor generates a fault signal at:

- the absence of Tx signal;
- the absence of supply voltage or at its reduction lower than 8 mV;
- Rx or Tx failure.

When a fault signal is generated, the individual point relay contacts are broken, and a fault signal is transmitted over RS-485 interface up to the malfunction repair.

1.2.7. When the exchange is interrupted over RS-485 interface, a fault signal is generated by the alarm complex.

1.2.8. The sensor generates an alarm at the opening of Rx and Tx cover, under which there are adjusters. The contacts of the tamper button (TAMPER) are open at the cover opening. This alarm is transmitted from Rx and Tx by the separate pair of cables.

1.2.9. The sensor doesn't generate false alarms at:

- rain, snow, thick fog;
- solar radiation;
- wind speed up to 30 m/sec;
- objects moving with the linear dimensions up to 0,2 m (birds or small animals);
- irregularities up to $\pm 0,3$ m;
- snow up to 0,5 m (without additional adjustment);

- grass up to 0,3 m;
- the influence of ultra-short waves emissions of the range 150-175 MHz and the power up to 40 W at the distance 6 m maximum.

1.2.10. The sensor is immune to electromagnetic interferences (voltage impulses in supply circuits, breaks of mains supply, electrostatic discharges and electromagnetic fields).

1.2.11. The case of the sensor is made of impact-resistant plastic immune to UV radiation and the temperature changes in all the performance range.

1.2.12. The sensor mean lifetime is 8 years.

1.2.13. Maximum dimensions of the units without a mounting kit, mm:

- transmitter - 165x97x65;
- receiver - 165x97x65.

1.2.14. Maximum weight of Rx +Tx units with a mounting kit – 1.5 kg.

1.3. Sensor components

Receiver – 1 pc

Transmitter – 1 pc

Mounting kit (MK) including:

- bracket – 2 pcs
- buckle – 4 pcs

Kit of tools and accessories including:

- screwdriver;
- spanner 8x10.

User manual

Package.

The protocol converter USB/RS-485 with the port isolation cable for PC connection USB2.0 A – miniB are supplied at the customer order.

1.4. Operation principle

1.4.1. The sensor is a bistatic microwave device.

The sensor principle of operation is to generate an electromagnetic field between Tx and Rx. This field forms a volumetric detection zone in the form of a long ellipsoid of rotation. The sensor registers changes of the field when an intruder crosses a protected area.

1.4.2. An intruder crossing the detection zone causes some changes of the signal amplitude in Rx. The signal passes through the amplifier and is compared with the thresholds value according to the algorithm. If the signal change on Rx input is provoked by a person passage, then Rx generates an alarm, breaking actuating relay contacts. The signal changes depend on: height and weight of the intruder, place of the sector crossing, its relief and speed of the movement.

1.4.3. The signal on Rx input can be changed under the influence of other interference factors: precipitations, vegetation, small animals, electromagnetic interference, swinging of tree branches or gates, crossing the detection zone and which are commensurable with intruder movements.

Other reasons, e.g. location of extensive constructions in the detection zone or near it (fences, walls), irregularities and snow can influence on the Rx input signal. In these cases the detection zone form is distorted because of re-reflections and interferences.

Multi thresholds operation algorithm permits to reduce the number of false alarms.

That's why one should observe the recommendations of the subsection 2.1.

1.4.4. The alarms reception and indication are performed with the security system controlled by the relay contacts, and with the security systems operating with RS-485 interface. When an alarm is generated, the normally closed contacts are broken.

1.4.5. You can use laptop to adjust and control the sensor operation. The remote adjustment is also possible; you can control the sensor with the alarm complex over RS-485 interface.

1.5. Sensor structure

1.5.1. The detector consists of separate units (Rx, Tx) placed in dust-, splash-proof enclosures.

1.5.2. Rx Construction and its fastening elements to the support are given in fig. 1.2 The carrier of the unit is base . Radio transparent enclosure is fixed to the base with fixing elements. In the heel of the enclosure there are two holes preventing condensed fluid accumulation within the unit. The access to the controls, adjustment, indication elements and clamps for the connection of the terminal element is open when the cover is removed. Rx is connected to the alarm control device with eight wires cable . Rx is mounted on the support using the bracket and two buckles . Mounting provides the rotation of the unit horizontally at angle $\pm 65^\circ$ minimum; vertically: upward - at angle 30° minimum, downward – at angle 45° minimum (if the bolt 12 is eased). Location and marking of the clamps, controls, and adjustment and indication elements located under the cover are shown in fig. 1.3.

1.5.3. Tx construction and its bracket are the same as the Rx construction (see fig. 1.2). The difference is in internal elements: under cover are shown in fig. 1.3 (b) Rx; eight wires cables are used instead of four wires cable 1.3 (a) Tx .

1.5.4. Mounting kit includes two brackets and four buckles for the mounting on the support of Rx and Tx.

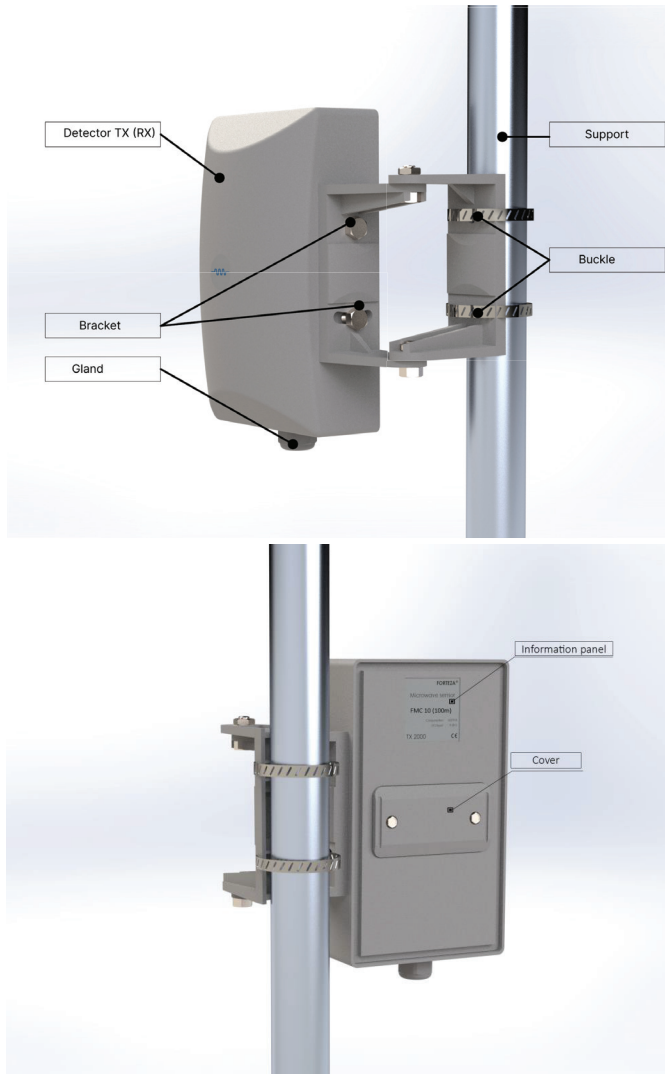
**Fig. 1.2**

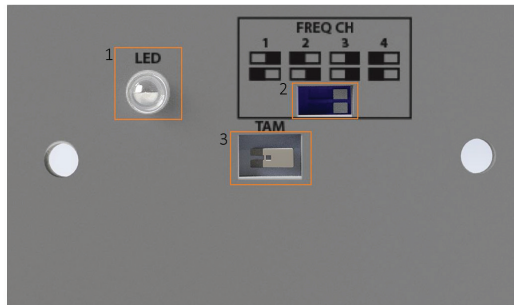

TX (transmitter)

- 1 – indicator "LED"
- 2 – frequency channels switches
- 3 – tamper circuit "TAMPER"

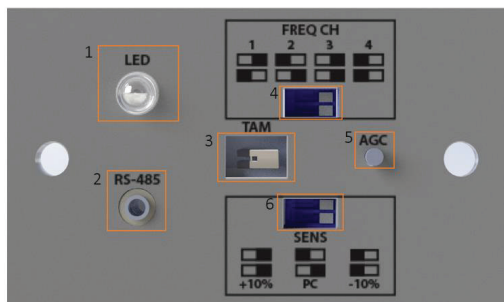

RX (receiver)

- 1 – indicator "LED"
- 2 – socket "RS 485"
- 3 – tamper circuit "TAMPER"
- 4 – frequency channels switches
- 5 – button "AGC"
- 6 – sensitivity switches

Note. Dear user! The manufacturer of the detector constantly upgrades their quality and reliability. That's why in some lots of detectors one can find design modifications unspecified in the documents delivered with the detectors. Nevertheless, the main specifications are valid.

1.6. Adjustment, control and indication parts

1.6.1. The micro channels switches provided the frequency channels switch is set on the transmitter and the receiver. Only one of four switches can be set with the same number on the receiving and the transmitting side when the power supply is ON.

CAUTION! Set the frequency channels only when the power supply is OFF!

If you switch a frequency channels on the operating sensor, the channels is not changed, but after the power supply is switched ON/OFF the channels number is changed.

1.6.2. The adjustment, the control and the sensor indication is performed by the controls of the receiver LED indication, software FORTEZA FMC software on PC.

1.6.3. Manual adjustment: calibration of detector signal using LED indication Sensitivity adjustment.

1.6.4. Adjustment using PC: calibration visualization; selection of detection zone length; AUTO or MANUAL sensitivity adjustment modes.

1.6.5. To prevent unauthorized openings of the cover (fig. 1.2), a tamper button is placed in the receiver (fig. 1.2). The button contacts are closed in the operating state. When the cover is opened, the contacts are broken providing the circuit opening TAMPER.

2. INSTALLATION AND ADJUSTMENT PROCEDURE

The preparation to the sensor operation is the following:

- preparation of the sector;
- signal cables and power supply laying;
- Tx and Rx installation;
- sensor connection (connection of power supply and intruder alarm loops);
- alignment of Tx and Rx antennas
- Rx thresholds setting.

The principles and methods of these steps are given in i. 2.1-2.8.

2.1. Requirements for the protected sector of Rx and Tx alignment

2.1.1. The sector where Tx and Rx are located should meet the following requirements:

a) The height of irregularities should not exceed $\pm 0,3$ m. If irregularities of the sector surface from the plane exceed $\pm 0,3$ m, the specifications of the detector can worsen. In this

case the issue of the use of the detector under these conditions is defined by the trial operation.

- b) The height of the grass should not exceed 0,3 m;
- c) The height of the snow should not exceed 0,5 m;
- d) The maximum incline of the sector is 40°;
- e) Single fixed objects (e.g. posts, trees without lower branches) can be situated in the detection zone at the distance of 0,5 m minimum from the axis;
- f) The width of the sector should meet item 2.1.3.

2.1.2. The detector can be mounted if the width of the sector is less. In this case if “Calibration mode” voltage is less than 1.2 mV, it is necessary to change Rx and Tx position relative to the support. For example, if Rx and Tx are at the left from the support, turning the wall bracket relative to the support at 180°, fix Rx and Tx at the right from the support. If it is not successful and “Calibration mode” voltage is less than 1.2 mV, make a decision about the possibilities of the detector operation in these conditions (see Table 4.1).

2.1.3. Moving objects influenced by wind: wings of gate, bushes, trees branches, etc. **should not be situated** in the detection zone and at the distance of:

± 1,7 m from the axis connected Rx and Tx at the perimeter length **from 10 to 50 m**;

± 2,2 m from the axis connected Rx and Tx at the perimeter length **from 50 to 100 m**;

± 2,6 m from the axis connected Rx and Tx at the perimeter length **from 100 to 200 m**.

2.1.4. Sector width should not be less than the detection zone one (see **Table 1.1**).

The sensor can be mounted if the sector width is less. In this case the sensor application is determined by trial operation.

2.1.5. The range of the sector’s slope is 40° maximum.

2.1.6. The sensors with different channels should be mounted on the neighbour sectors. When the sensor is mounted one after another on the sectors, a number of the channels should be repeated successively from 1 to 4 providing the maximum distance of the sensors with the same letter.

2.1.7. To increase the detection zone in the height, it is possible to align the sensors in two tiers. The sensors should have different channels; two transmitters should be installed from one side of the protected area, two receivers – from another one. The sectors lengths should be identical.

2.1.9. The sensor can limit the maximum intruder’s speed. If the maximum intruder’s speed is reduced, the interference immunity will be increased. The manufacture produces the sensors with the maximum intruder’s speed of 10 m/sec (“high”). You can reduce the maximum intruder’s speed up to 4 m/sec (“middle”) and up to 1 m/sec (“low”)*. You can change the intruder’s speed with PC. After that it is necessary to set the alarm sensitivity again.

e.g. open perimeter area – high intruder’s speed; the zone between a fence and an auxiliary one (an intruder can’t rush) – middle intruder’s speed; sensor mounting on the top of the fence – low intruder’s speed.

2.2. TX and RX mounting

2.2.1. Mark the perimeter area for the places where the supports will be mounted. To generate a continuous protected boundary, the installation of Tx and Rx **isn’t permitted** on adjacent perimeter sectors. The right installation on adjacent perimeter sectors is Tx and Tx, Rx and Rx. To generate the continuous protected boundary, it is necessary to provide the overlapping of the sectors detection zones (see fig. 2.1 and 2.2). The overlapping is necessary to eliminate the possibility of the sector overcoming under or above Tx (Rx) unit near the support.

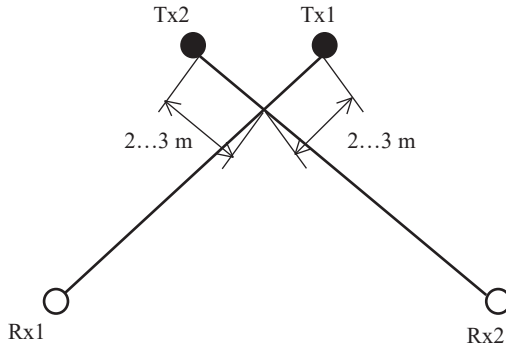

Fig. 2.1

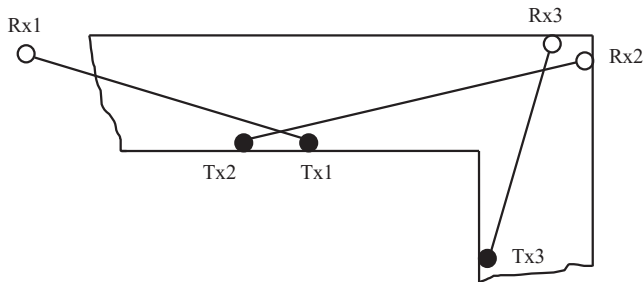
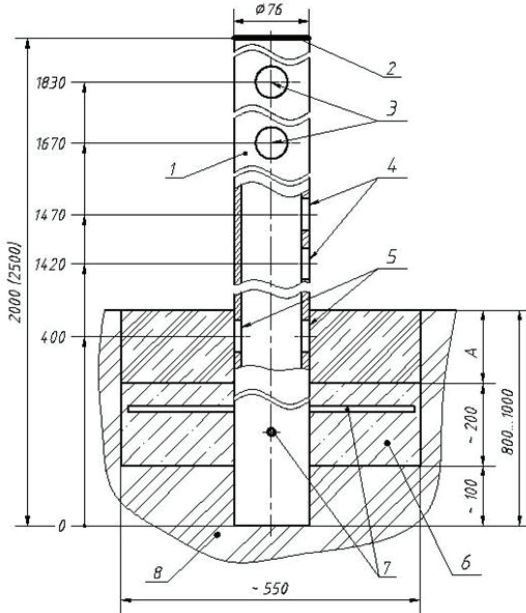

Fig. 2.2

Note: To avoid co-interference between neighboring detectors, you can adjust them to different operation channels (don’t forget to change receiver’s and transmitter’s operation channels too with the mentioned way in the manual).

Note: Avoid installation in a way where the reflected microwave signals (by metal fences and other metal objects or by wet surfaces after rain and snow) may cause interference and false alarms.

2.2.2. Mount the supports. It is recommended to use metal or asbestos-cement tube as supports of 70...90 mm diameter. The height of the support above the surface of the ground is given in fig. 2.3. In the places where there is a lot of snow, the superstructure of the support should be 1500 mm minimum. As for the support construction, it is necessary to provide some dowels for concreting and some holes for the cable gland.



- 1 - support;
- 2 - plastic plug;
- 3 - hole for the cable input inside the support;
- 4 - hole for the main cable and sensor cable input;
- 5 - hole for the main cable input;
- 6 - concrete (gravel);
- 7 - dowels for prevention the unauthorized dismantling of the support;
- 8 - ground

Fig. 2.3

Note.

1. For A size the ground should be laid after installation works.
2. Dimensions are given in millimetres (mm).

2.2.3. Other variants of the sensor mounting (for example on the fence or wall) can be applied according to the protection tactics. If the sensor blocks the top of the fence, it is recommended to fasten the support with the fence with a solid mechanical or welded joint.

Table 2.1

Detector	Max detection zone length (L), m	Max detection zone width (b), m	Max detection zone height (h), m
FMC 10 (50m)	30	1,5	1,5
FMC 10 (100m)	50	1,5	1,5
FMC 10 (200m)	100	1,5	1,5

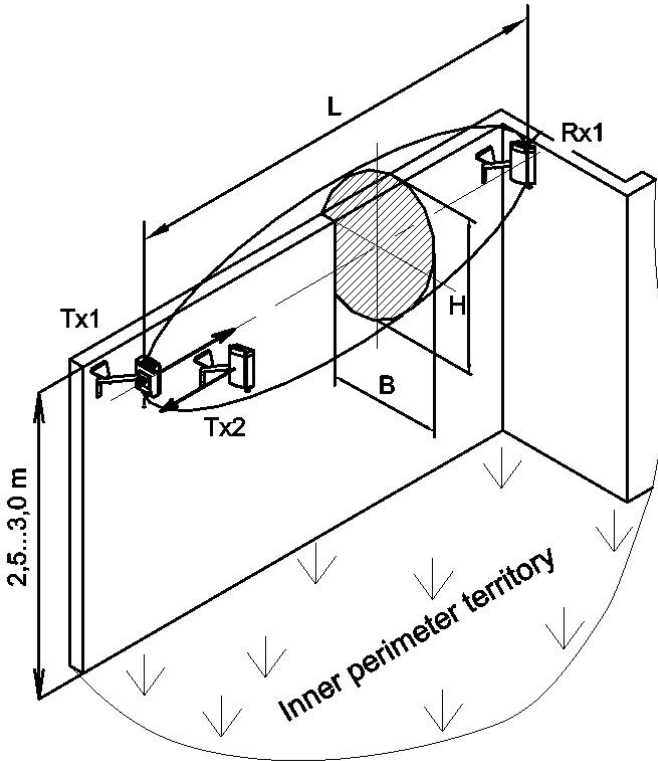

Fig. 2.4

2.2.4. Lay the main cables according to the project of the security system. It is recommended to use multicore cables with the core screen or metal sheath. The cable core section is chosen on condition that the supply voltage is not less than 9 V for every sensor unit. It is not recommended to lay the main cables near heavy electromagnetic interference sources (power lines, antenna systems, and etc.) and to use free cable cores for impulse signal transmission. **CAUTION! To reduce the level of electromagnetic interferences, it**

is recommended to mount the power supply unit at a distance up to 300 m from the place where the sensors are installed.

2.2.5. The mounting kit (MK) for mounting on the top of the fence can be delivered on the customer order to protect the perimeter site from the intruder climbing over the fence and the intrusion into the window. The example of the sensor installation with the brackets application 350, 500 mm is given in fig. 2.4. The detection zone sizes are shown in Table 2.1. The angles to turn horizontally the sensor units on the brackets are 180°, vertically: up – at the angle of 17°, down - 40°.

Notes.

- 1. If the upper part of the fence is protected with physical protection devices, it is necessary to use the bracket of 500 mm. If the upper part of the fence is not protected with barbed wire, it is recommended to use the bracket of 350 mm.*
- 2. The height of Rx and Tx units for the protection of the fence upper part is equal to the fence height ± 100 mm.*
- 3. The dimensions and materials of the fence are not specified. It is necessary to provide the fence rigidity.*
- 4. The detection zone dimensions b and h are given for the correct alignment of the sensor according to points 2.4 and 2.5.*
- 5. To avoid co-interference between neighbouring detectors, you can adjust them to different operation channels (don't forget to change receiver's and transmitter's operation channels too with the mentioned way in the manual).*
- 6. Avoid installation in a way where the reflected microwave signals (by metal fences and other metal objects or by wet surfaces after rain and snow) may cause interference and false alarms.*

2.2.6. Mount Tx and Rx on brackets with bolts 12 (fig.1.2).

2.3. Sensor connection

2.3.1. Connect the necessary power, signal and remote control circuits. Rx and Tx unit is connected with its own cables. The color or marking of the cable conductors indicate their purpose.

The information about cable conductors marking, color and purpose is given in **Table 2.2.**

2.3.2. Set the operation channel of the sensors with the channels switches of Tx and Rx.

Table 2.2.
RX

Color	Purpose	Marking
Blue	Power supply	« - »
Red		« + »
Brown	Normally closed contacts of actuating relay NC	NC
Orange		NC
Black	Tamper button contacts	Tamper
Yellow		Tamper
White	Contacts of RS-485 connection	RS A
Green		RS B

TX

Color	Purpose	Marking
Blue	Power supply	« - »
Red		« + »
Black	Tamper button contacts	Tamper
Yellow		Tamper

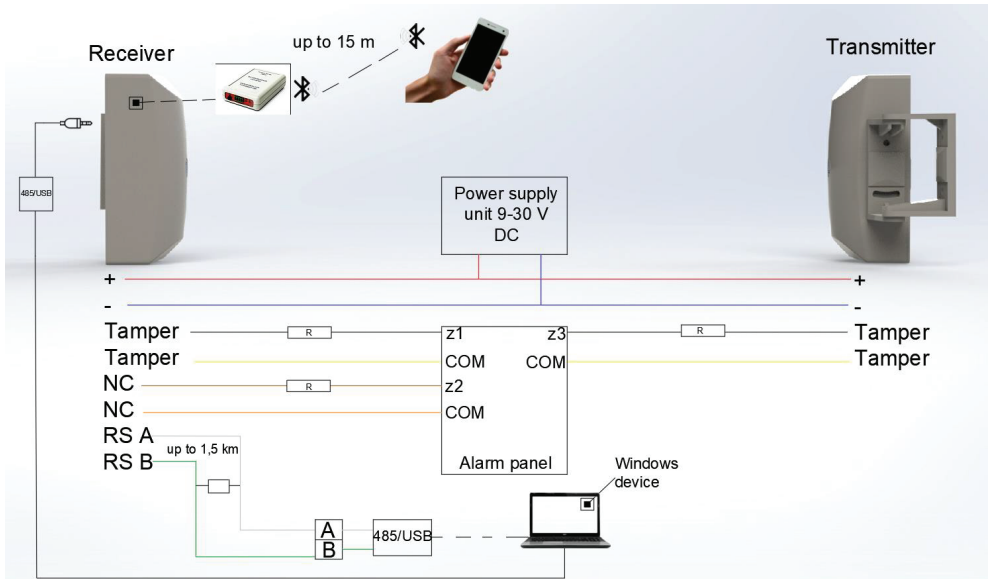

Fig. 2.5

Warning: Do not open the detector's housing, because it may damage the device!!!

Note: Always use separated cables for the power supply circuit as the cables for the alarm signal circuit to avoid unexpected alarms.

Note: The alarm contact loading capacity is up to 30 Vdc 0.1 A.

Note: All the electronic connections should be carried out only after power is disconnected.

2.3.3. The type and the nominal of the terminal element of the security systems loop (resistor, condenser and diode) are determined by the type of the control device. The detector is connected to the control device. Usually it is a resistor. The nominal resistance of this resistor should take into the clamping resistor of the lightning circuit (this resistor - 100 Ohm) and resistance of the security systems loop (depends on the chosen cable type and its length).

2.3.4. The contacts of the tamper circuit (“TAMPER”) of Rx or Tx can be connected to the receiver control device by the separate loop. In this case the user receives the information of the opening of the Rx or Tx terminal covers with the separate signal. The second variant: the individual point relay is switched ON in series with the contacts of the individual TAMPER relay. In this case an alarm will be generated when:

- the individual point relay functions;
- the opening of the Rx or Tx terminal covers on one channel of the control device.

2.4.2.2. Channels set up. The receiver and transmitter should be adjusted to the same signal frequency. It is necessary to set the different channels to nearby detection zones.



FREQ CH switches

Note: You can check which channel receiver and transmitter in operation by switches FREQ CH position.

2.4.2.3. Check the right connection of supply circuits and output circuits of the detector. Switch ON the power supply.

2.4.2.4. When power is supplied to detector Rx and TX units, the “LED” blinking indicates the frequency channel after additional information:

TX - “LED” blinks once per 2 sec it means that power is connected and it is acceptable range.

RX - after 3-5 sec Rx “LED” is switch off which means that detector is in operation mode.

2.4.2.5. After 1-2 minutes after tuning the power supply, check the status of “LED” indicator: the indicator should be off, that informs, detector is in standby mode.

Note: In situation, if the indicator Rx continuously on, periodically and briefly goes out or lights up-determine the problem and correct it using table 4.1

2.4.2.6. Sensor calibration is performed incrementally and consists of a set of repetitive actions. The alignment can be started with both transmitter and receiver. In the alignment mode, the detector switch, when you press and hold down the button, "AGC" on receiver. The indicator “LED” is switched ON.

2.4.2.7. Tx and Rx are adjusted on the angle of the place and the azimuth according to “LED” blinking’s (on the RX). Two persons are necessary for the detector calibration. One of them is situated next to Rx, the other – next to Tx.

The calibration includes the following actions:

- a) Loosen the bolts (see fig. 1.2) of Rx; Loosen the nuts;
- b) Press and hold the button “AGC” on Rx. Rotate Rx horizontally, seeking the maximum signal flashes, then rotate the Rx vertically, seeking the maximum signal (the most frequent LED indicator flashes). Release the „AGC“ button.
- c) Repeat actions a) and b) to calibrate the TX.

Repeat the paragraph b) If during the repeat of paragraph b), rotating the unit vertically or horizontally the flashing of LED indicator slows down the adjustment will be complete. Otherwise one more time repeat articles in the following sequence a) and b).

- d) Tighten the bolt;
- e) Tighten the nuts;

Check the buzzer signal speed and “LED” blinking’s as a result of the adjustment.

Rx and Tx must directly at each other for stable operation. Don’t misalign Rx and Tx down or a side.

2.4.2.8. After commencing the adjustment, wait for the sensor to switch in to working mode (1-2 minutes), the LED should go out.

2.4.2.9. Complete the described actions for the Tx, controlling the signal level according to the indicator of Rx. For coordination of actions use the talk set.

2.4.2.10. If the LED shines and rarely turns out - the calibration signal voltage is in the upper critical point of the allowed diapason - a) the increasing of distance is needed between Rx and Tx or b) disalign the sensors by turning them up. If the LED rarely flashes - the power of the signal is in the lower point of the allowed diapason - it is needed to lower the distance between Rx and Tx or change (with 4-5 cm interval) the placement of Rx or Tx from the ground down or up.



2.4.3. Sensitivity setting manually

2.4.3.1. Standard switches SENS in the position  this means that sensitivity is set from computer. You can change the sensitivity +10% or -10% percent’s using switches if it necessary.

2.4.3.2. Sensitivity is adjusted according to the protected sector crossing at the “full height” or “bent” (crawling) along its whole length. It is recommended to begin doing these check passages in the middle of the protected area. It is necessary to go out of the detection zone at a distance of 1-2 m and to pause from 5 to 7 sec. Otherwise, the results of the previous passage will influence on the next one.

2.4.3.3. When the sensor generates alarms, “LED” indicator shines for 3 sec. After the switching ON of the indicator “LED”, the following passage can be done.

2.4.3.4. Do some check passages in “problem” places of the detection zone: hollows, hills, near to barriers, buildings, and trees situated in the detection zone. If it is necessary change the sensor sensitivity.

2.4.3.5. We offer to set switchers in position – 10%  and cross the detection zone in different points. In case if the detector is not generated alarm during the investigator passage, set first switchers to position  and after that to position + 10% .

Note. If switcher's is in position + 10% , but the detector is not generated alarm during the investigator passage, please use computer to adjust the sensitivity.

2.4.3.6. When the adjustment is over, it is necessary to close Rx and Tx terminal covers.

2.4.3.7. After the sensor adjustment it is recommended to carry out its trial operation for 2...3 days to reveal and eliminate possible errors of mounting and adjustment.

2.5. Software installation and detector adjustment by means of PC or any ANDROID device (using RS-BL converter)

2.5.1. Checking the signal level, changing the sensitivity parameters and the length of detection zone generating the signal, and setting other parameters that cannot be set during the stage of preliminary adjustment, can be done by means of computer or any ANDROID device.

2.5.2. PC software installation

2.5.2.1. You can download the latest version of setup software from our website download menu <http://www.forteza.com>

2.5.2.2. Connect the sensor to PC with RS 485 throw USB, power to the sensor. The computer determines the type of USB device and installs the driver on COM-port. If the driver is not installed automatically, the computer asks to install the driver. You can find driver in Forteza FMC SOFT file.

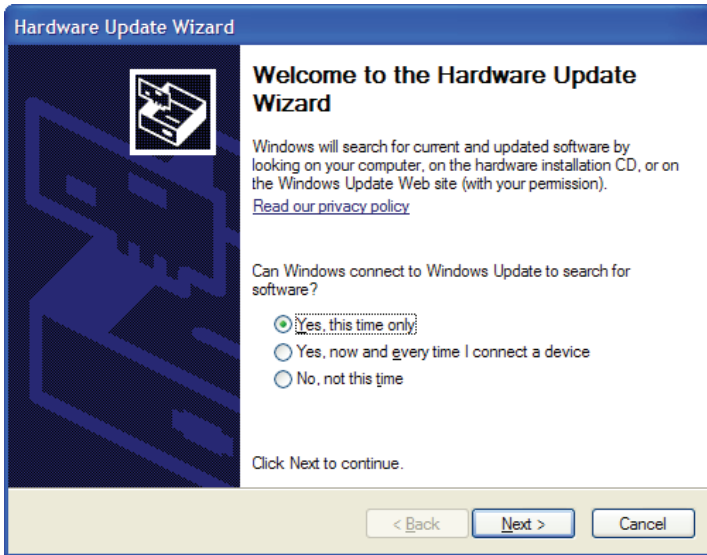

Fig. 2.7

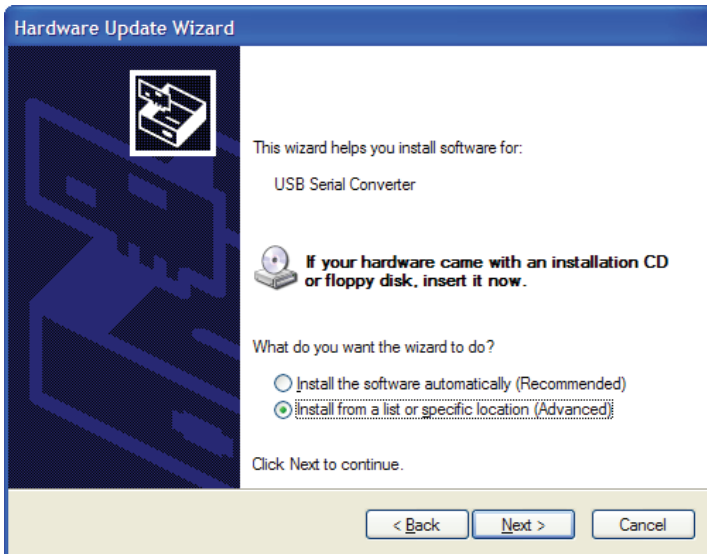

Fig. 2.8

Please choose the folder COM-PORT from the earlier unzipped file in the window Search.

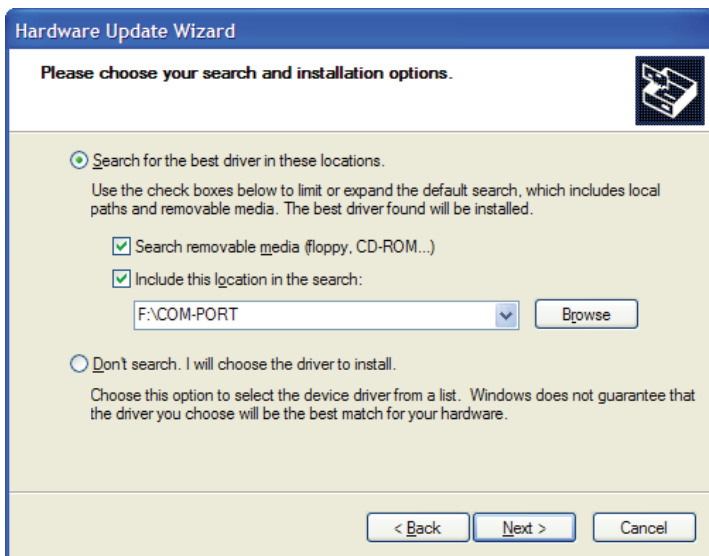

Fig. 2.9

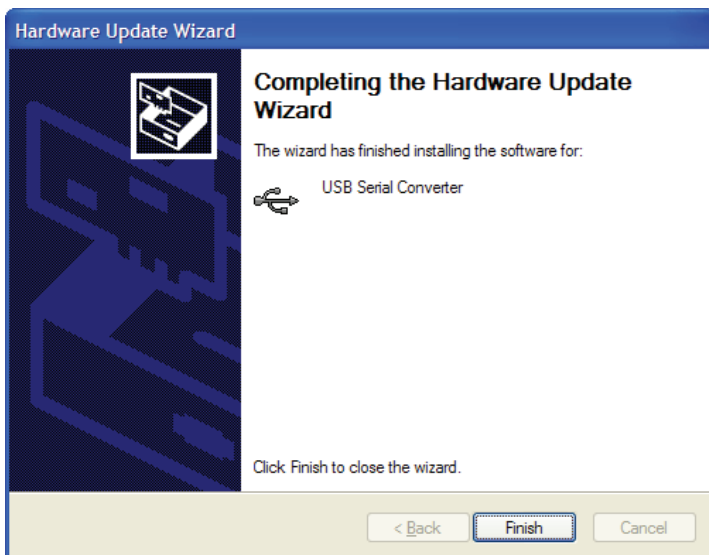

Fig. 2.10

2.5.2.3. Sensor Connection with computer. For FMC 50/100/200 detectors is using converters RS485/USB.

You can choose 2 variants for connections.

- 1) Connect the programming extension cable through converter to the receiver socket “RS-485” using the connection cable from FORTEZA RS-485/USB kit. (see Fig. 2.6)
- 2) Connect the programming converter RS-485 to connection cables RS A or RS B (white and green) from RX 8-cable (see Table 2.2)

2.5.3. Forteza FMC software menu.

2.5.3.1. After unzipping the Forteza FMC adjustment software, if you double click Forteza_FMC.exe, it starts immediately (without any installation). The following initial screen will appear:

2.5.3.2. Please select the proper communication port from the appearing list.

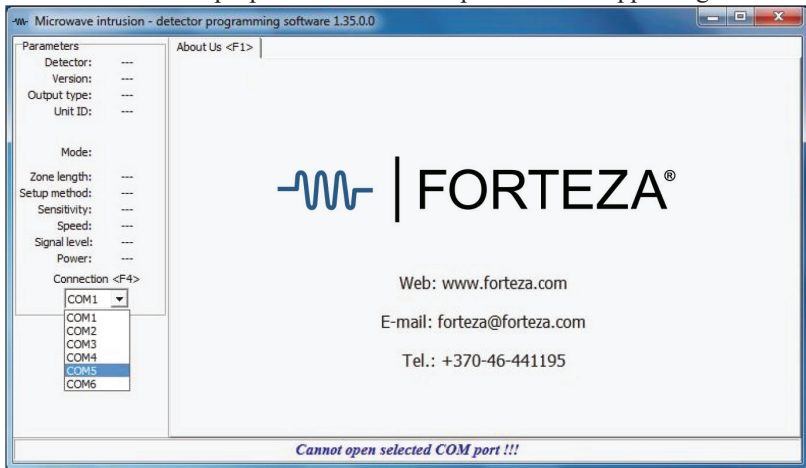

Fig. 2.11

Note: If there is any communication problem, try to change RS485A and RS485B wires in the converter and check the driver installation of RS 485 converter.

Note: You can find the COM port settings in the manual of your converter. Or you can check the used COM port in Start menu / Control panel / System / Hardware / Device manager / COM ports in Windows operation system.

2.5.3.3. After choosing the proper com port, the communication with the device starts automatically.

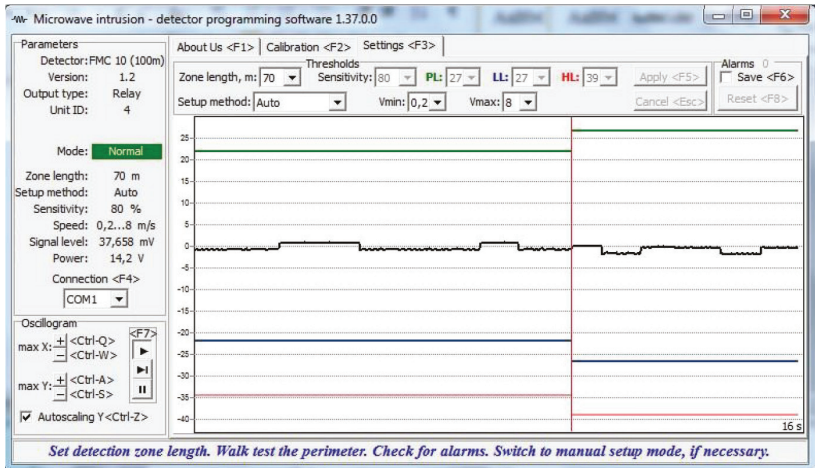

Fig. 2.12

2.5.3.4. In the left side of the screen you can see the current setting parameters. They have the following meaning:

Detector: Information about detectors model *FMC*, operation frequency *10* (10.525 GHz), operation length up to (*100m*)

Version: Version of software

Output type: Relay (normal close contact)

Unit ID: It means the frequency modulation channel of the receiver. The transmitter and receiver should be on the same frequency modulation channel (1 ~ 4). Frequency modulation channel changing using the switches (see 2.4.2.2.)

Mode: ‘Normal’ or ‘Alarm’ mode of the detector. There should be ‘Normal’ before fine tuning (calibration). ‘Normal’ means no alarm; ‘Alarm’ means alarm state.

Zone length: The currently selected operation distance for the detector. It is really important to choose the proper operation distance.

Note: Window is active only in Setup Method: AUTO

Note: If the zone length is not the real distance, there might be higher false alarm rate or poor sensitivity.

Setup method: The currently selected setup method. You can choose “Auto, ‘Manual’, SPECIAL 1 or SPECIAL 2 setup modes. In ‘Manual’ setup you can set sensitivity, in ‘Auto’ setup you can change ‘Zone length’. **In most of the cases ‘Auto’ setting is recommended.**

Sensitivity: It means the sensitivity of detection. You can only set sensitivity in ‘Manual’ Setup method. In most of the cases sensitivity setting is not recommended.

Speed: It is the motion speed range which is identified by the detector.

Note: *Too big speed range has higher false alarm rate, too low speed range has poor sensitivity.*

Signal: Shows the signal between transmitter and receiver.

Save alarms: It is a useful function if the installer is alone. With this function you can count alarms, so you can check your detector with test crossings. With ‘Reset’ button you can reset the counter.

Main Screen: Black line – averaged signal. Changing depending of influence to detection zone from intruder and and other objects (see 2.1.3.).

Green and Blue penetration thresholds levels work as one. Intruder detection in the middle of detection zone. Alarm is generated then average signal crosses both penetration threshold levels for 0.5 sec. time.

Red penetration threshold level. Intruder detection in the space 30 meter from TX and 30 meters from RX. Alarm is generated then average signal cross penetration threshold level for 0.5 sec. time.

2.5.4. Sensor adjustment with PC

2.5.4.1. Perform a preliminary adjustment of Tx and Rx with a sight leaf (i. 2.4.1).

Check if the switcher of sensitivity of the receiver switched to  position.

2.5.4.2. Before any changes in Setup bookmark, you need to calibrate your detector. You can make it if you select Calibration bookmark.

2.5.4.3. Firstly you need to calibrate (fine positioning) the transmitter unit, then the receiver unit.

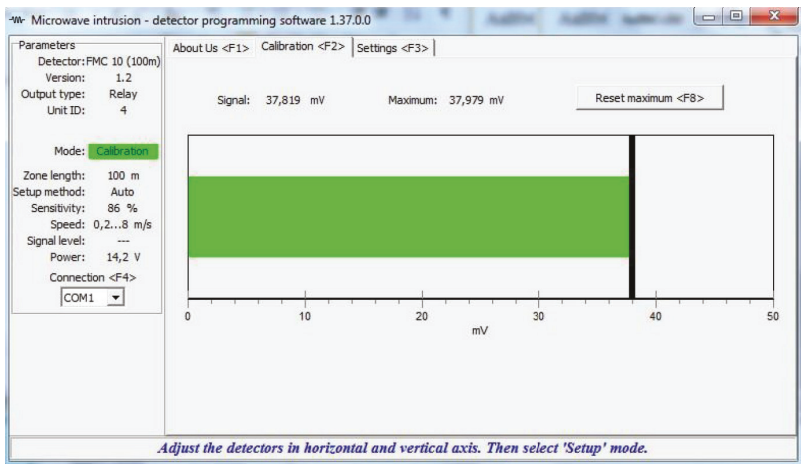

Fig. 2.13

2.5.4.4. Here you can see the received signal from the transmitter on a dynamically changing scale. The maximum value of the current positioning is always signed. If you are close to the maximum value of the current positioning, the changing lane becomes green. It means the positioning made well. If the lane is red, you should continue positioning as you are not close to the maximum value. With 'Reset maximum' button you can reset the current maximum, and you can look for another reference value.

Note: This is the same alignment (see 2.4.2.7.) were you use LED blinks.

Note: Always recommended a few minutes of positioning to have a good maximum value of current positioning, what you can use as a reference.

2.5.4.5 Check the value of "Calibration" voltage as a result of the adjustment. If "Calibration" voltage is less than 1.2 mV, it is necessary to repeat the alignment vertically and horizontally for more exact adjustment. The boundary values of 8 mV and 200 mV during the adjustment are recommended for the resource of the signal level to provide a long operation;

NOTE: *There should be at least 10 mV minimum signals. Detectors installation height is 85 cm. If you cannot reach it: change the position (85 cm + 5 cm or 85 cm – 5 cm.) of the detectors or the operating distance;*

2.5.4.6 If the voltage controlled by the calibration is over 290 mV (on short sectors), it is recommended to make the desalignment of Rx and Tx upwards at a small angle so the voltage does not exceed 200 mV.

NOTE: *Don't desalting Rx and Tx down or sideways.*

2.5.4.7 Don't desalting Rx and Tx down or sideways. The detector keeps its operation using "Calibration" voltage 1.3 mV. The recommended boundary values of 10 mV and 200 mV during the adjustment are recommended for the resource of the signal level to provide a long operation.

2.5.5. Detectors sensitivity setting with PC

2.5.5.1. Switches SENS in the back of RX must be in the position PC  this means that sensitivity will be set from computer.

2.5.5.2. After successful calibration you can come back to setup menu. Here you can define the working parameters of the detectors. Signal must be stable, within the range +7 mV or -7 mV, if the noises signal is changing more than +7 mV or -7 mV please check the detection zone, there can be moving objects. If you can't remove them or there is no moving object which can make influence to detection zone, please use manual setup method. We're set up the sensitivity level 2-3 times higher than existing noises signal level. Follow 2.5.5.4. if detector don't generate the alarms throw passages, clear the detection zone us write in 2.1.3.

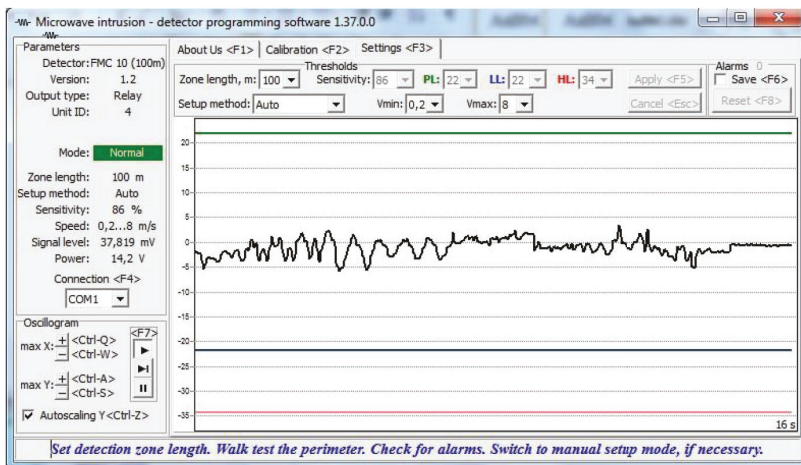

Fig. 2.14

2.5.5.3. Setup Method: Auto in most of the case ‘Auto’ mode and default sensitivity value is recommended. The most important is to set the proper ‘Zone length’ according to the installation site, sensitivity value will be set up automatically. You can send your setting to the receiver with ‘Apply’ button, or you can cancel your settings with ‘Cancel’ button.

Note: If the zone length is not the real distance, there might be higher false alarm rate or poor sensitivity.

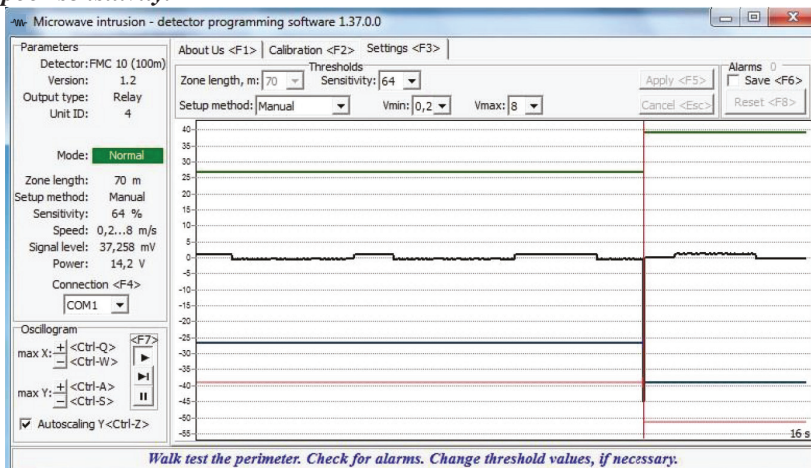

Fig. 2.15

2.5.5.4. Do these passages in “full height” and “bent” on different distances from Tx and Rx. It is recommended to begin doing these “approved” passages in the middle of the protected zone. After each passage it is necessary to leave the detection zone for the distance

of 1-2 m and make a pause from 5 to 7 sec. Otherwise, the results of the previous passage can influence on the next one.

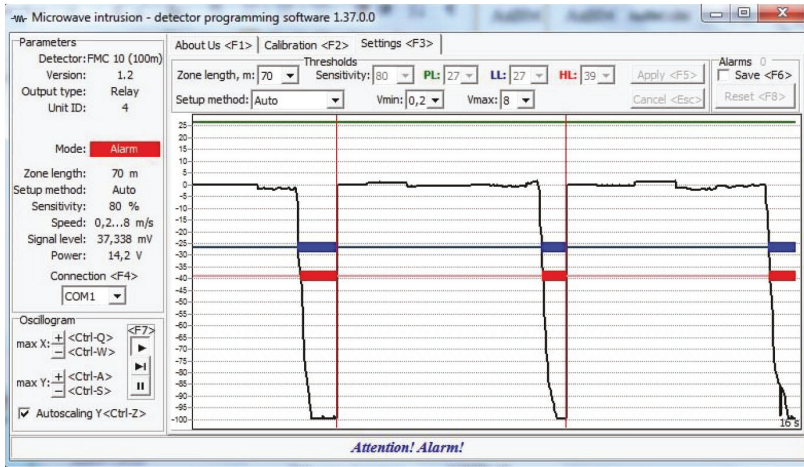

Fig. 2.16

2.5.5.5. You can change the minimum detected speed in m/s (Vmin), the maximum detected speed in m/s (Vmax). You can confirm your settings with ‘Apply’ button.

Note: *Too big speed range has higher false alarm rate, too low speed range has poor sensitivity.*

2.5.5.6. Setup method: Manual In ‘Manual’ setup method you can set sensitivity. But in most of the case ‘Auto’ mode and default sensitivity value is recommended. You can send your setting to the receiver with ‘Apply’ button, or you can cancel your settings with ‘Cancel’ button.

Note: *Black line – signal between transmitter and receiver*

Green and Blue – 1 section alarm thresholds

Red – 2 section alarm threshold

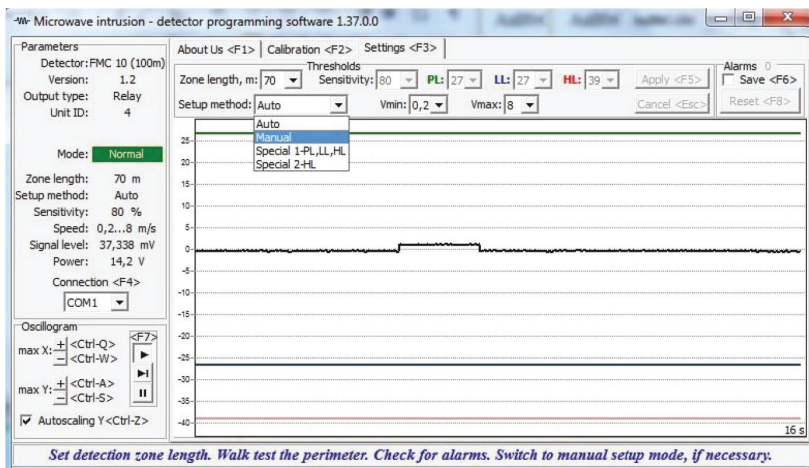

Fig. 2.17
Select method: Manual

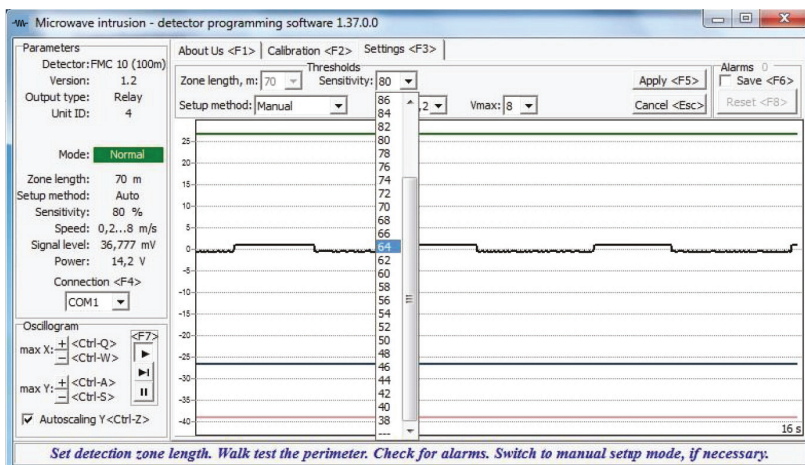

Fig. 2.18
Sensitivity window is active, zone length is deactive.

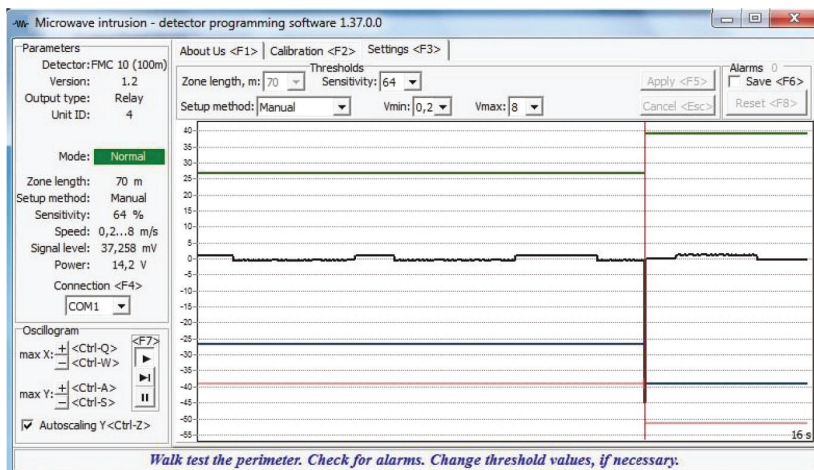

Fig. 2.19

After select 50 and press apply threshold level is changed, higher threshold - sensitivity is lower.

2.5.5.7. Set the sensitivity with the “approved” passages. Do these passages in “full height” and “bent” on different distances from Tx and Rx. It is recommended to begin doing these “approved” passages in the middle of the protected zone. After each passage it is necessary to leave the detection zone for the distance of 1-2 m and make a pause from 5 to 7 sec. Otherwise, the results of the previous passage can influence on the next one. If needed change the sensitivity.

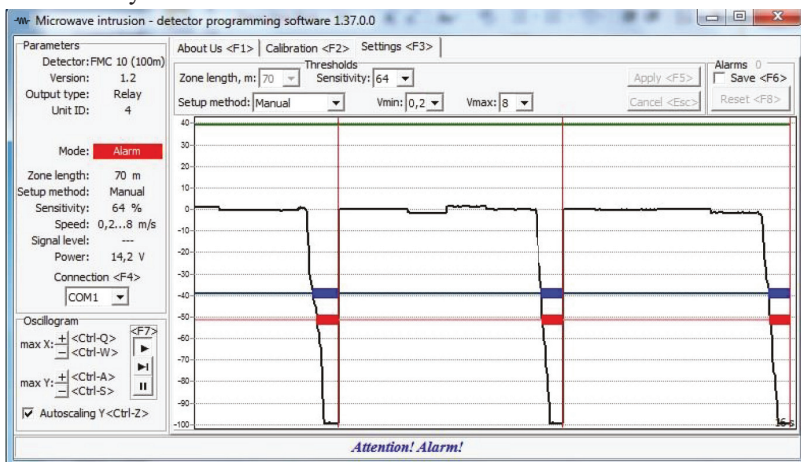

Fig. 2.20 Testing of detection zone

2.5.5.8. Then adjustment of sensitivity is completed. Disconnect the RS-485 and close the RX cover.

2.5.6 ANDROID software installation

2.5.6.1 The latest version of software setup can be downloaded from our website <http://www.forteza.com> or, on ANDROID device, from GOOGLE app PLAY MARKET by the name “FORTEZA FMC 10 and 24 (old modification)”.

2.5.6.2 For wireless connection of Android control panel to the detector it is necessary to do the following:

- Connect the “FMC – RS” cable (included in the set) to the terminals A and B of the RS-BL converter (Red – A; Black – B)
- Plug-in “FMC – RS” cable to the socket of RS-485.
- Turn on the converter by pressing power button.
- Run the android application on, search for RS-BL device. Device name is RS-485 BL*** (serial number is written on the case)

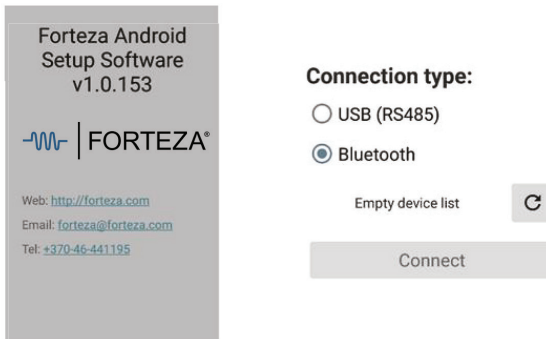

Fig.2.21

- Set connection and choose the RS-BL device with number. BL indicator should turn on.

2.5.6.3. Forteza FMC software menu.

Detector software desktop settings selection, functioning and changing are sufficiently described in paragraphs 2.5.3.3 – 2.5.5.8. The only difference is the desktop presentation.

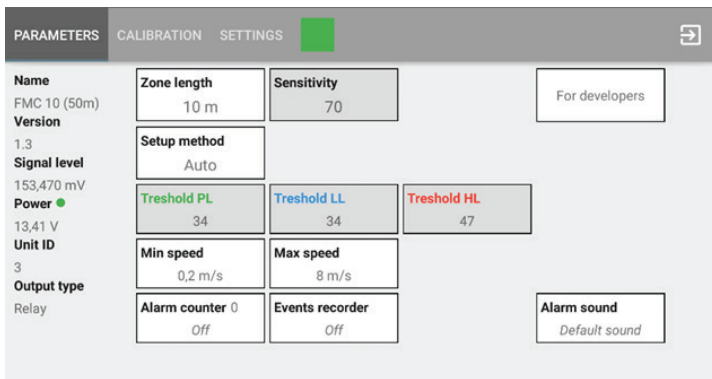

Fig.2.22

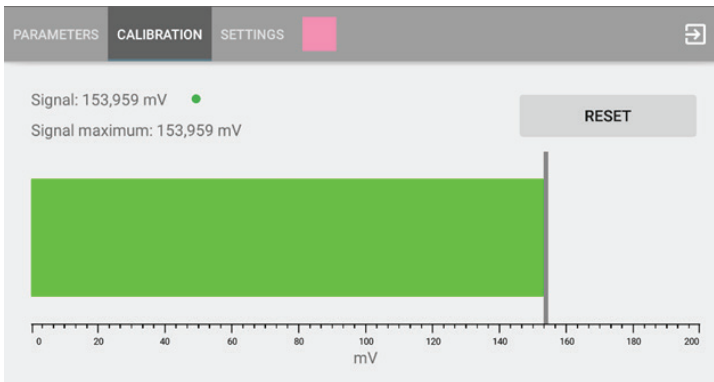

Fig.2.23

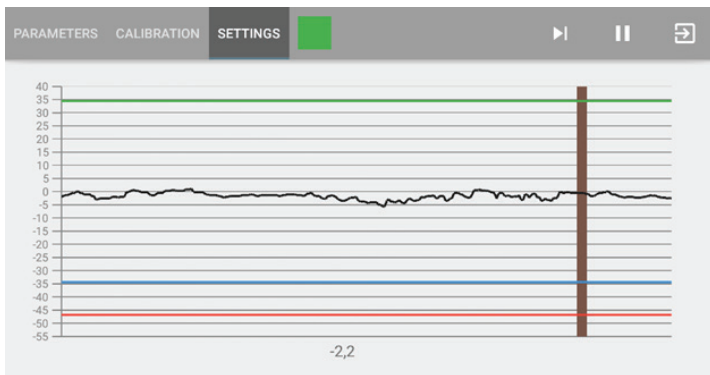

Fig.2.24

2.6. Trial operation

2.6.1. Running-in the detector means that a 24-hour testing period should be implemented after installation, preferably running for at least 3 days with all detections being registered and analysed. During running-in detector's operation should be checked twice a day by test crossing the detection zone. If false alarms are registered, or no alarms are registered during test crossings, check the sensitivity settings to eliminate defects.

2.7 Creation and saving of the report

2.7.1 In case you need to fix significant impacts on detection zone (during test crossings for example), not only when any response threshold (PL, LL, HL) is exceeded but also when there is an significant impact on the area without alarm notification, you can mark the screen ALARMS SAVE and then:

- a). A screenshot of detector's main active screen (settings) at the moment of impact is presented in additionally and automatically created file stored in software storage location;
- b). At the end of running the program, an additional report – archive (logs) is created;
- c). Program (1.48.0.0 version) is compatible not only with FMC series microwave detectors but also with Forteza PC detectors manufactured previously.

The innovation shall significantly facilitate the work when adjusting detectors, help to locate the reasons for “problematic areas” in complex objects. New software shall be especially useful to the installer at the object working without an assistant.

3. MAINTENANCE

3.1. Performance check

3.1.1. During the exploitation it is recommended to test the sensor operability 1 time per week by crossing the detection zone and check alarm in control panel.

3.2. Maintenance check

3.2.1. The sensor maintenance should be conducted by people, who underwent special safety trainings.

3.2.2. During the sensor exploitation it is necessary to conduct check and preventive works.

3.2.2.1. Every month carry out visual examination of the sensor units and the protected sector.

It is necessary to check:

- the absence of dust, dirt, snow and ice from the side of Tx signal transmission and Rx signal reception; clean the units if necessary;
- the absence of foreign objects in the protected sector.

3.2.2.2. Every quarter:

- carry out all monthly works;
- check the cables and cable connections.

3.2.2.3. The grass height is controlled during seasonal works. If the grass height is over 0,3 m, the grass should be mown down.

3.2.3. If the snow height changes, false alarms can be generated because of the signal reduction at the Rx input. In this case it is necessary to remove the snow or to change the height of Tx and Rx antennas.

After the height of the antennas is changed, they should be aligned. The thresholds should be aligned as described above.

3.3. Safety measures

3.3.1. The current safety standards for the operation with electrical facilities with the voltage up to 1000 V should be observed during mounting, preventive maintenance and repair of the sensor.

3.3.2. The sensor's power supply is 9...30 VDC. That's why before the sensor operation it is necessary to study the elements and cables arrangement in the power supply.

3.3.3. Cables should be laid, terminated and connected to the sockets only when the supply voltage is OFF.

3.3.4. Replace a fuse in the power supply when the power supply is OFF.

3.3.5. It is prohibited to mount and maintain the sensor at thunderstorms.

3.3.6. Installation and maintenance of the sensor must be performed only by people, who underwent special safety trainings and became acquainted with safety measures.

3.3.7. It is recommended to install a separate switch on the power supply line.

4. TROUBLESHOOTING GUIDE

List of possible troubles is given in table 4.1.

Table 4.1

Trouble	Possible Cause	Repair
1 .Receiver indicator shines and rarely turns out, the relay is closed.	The operation signal is in the upper critical point (290 mV) of the allowed operation diapason.	Increasing of distance is needed between Rx and Tx or desalignment of Rx and Tx upwards at a small angle.
2. Receiver indicator briefly (0.1 seconds) blinks with a period of 2 seconds, the relay is closed.	The operation signal is in the lower critical point (8 mV) of the allowed diapason.	Change detectors installation height (85 cm + 5 cm or 85 cm – 5 cm.) or it is needed to lower the distance between Rx and Tx.
3. Receiver indicator lights continuously (more than 15 sec), the relay contact is open	No operation signal from Transmitter or lower than 2.5 mV.	Press AGC button LED will blinks, sound is missing. 1.Check power supply on Tx.

		<p>2. Check the frequency channels on Tx and Rx, they must be on the same channel.</p> <p>3. Check calibration of detector. See point 2.4 in this manual.</p> <p>4. Tx or Rx is broken.</p>
	The operation signal is more than 290 mV.	Press AGC button LED will blink, sound is ON synchronized with blinks of the LED. Check calibration of detector. See point 2.4 in this manual.
4. Receiver indicator blinks briefly with a period of 4 ... 5 seconds, the relay is open	Adjustment is carried out using a computer or switch off the computer when the Rx was in «Calibration» mode.	Connect the computer and exit the „Calibration“ mode or restart the Rx by disconnecting the power supply.
5. The Receiver constantly generates alarms	Communication line is broken.	Check the cable integrity and the accuracy of its connection. Restore the communication line.
	The protective device in the supply unit is blown.	Replace the protective device.
	The detector alignment is disturbed.	Align Tx and Rx antennas.
	Channels of receiver and transmitter are different.	Check what channels was selected in receiver and transmitter
	Tx fails.	Replace Tx.
	Rx fails.	Replace Rx.
6. False alarms of the detector	Moving branches are in a detection zone and they cause alarms.	Inspect the sector and remove interference factors.
	High grass is in the sector.	Check the accuracy of the Rx sensitivity setting.
	Snow blanket is higher than one specified in the manual and this reduces an input signal.	

	Animals circulate in the sector.	
	The Rx sensitivity is too high.	
7. The detector does not generate alarms when an intruder crosses the sector.	Rx sensitivity is too low.	Check the accuracy of the Rx sensitivity setting.
8. The receiver connection with computer is broken.	RS-485 driver installation with mistakes	Reinstall the driver
	If using the RS-485 connection cable 8 (see Table. 2.2 (white RS A, green RS B), was changed then connected.	Check connection of RS A and RS B

5. STORAGE

5.1. The detectors should be stored in the package in warehouses at an ambient temperature +5 C...+30 C and relative humidity 85% maximum.

During storage the influence of hostile environment should be prevented.

6. TRANSPORTATION

6.1. Packaged detectors can be transported by any transport (if by plane – in pressurized modules) if they are transported in covered cars, holds or covered bodies they can be transported at the distance up to 10 000 km.

The boxes should be placed to prevent their shifting or fall in case of jolts and blows.

Microwave Intrusion Sensor “Forteza FMC 10 50/100/200”

The purpose of the sensor and its specifications are given in the corresponding clauses of the data sheet of the Description Manual & Service Instruction No. 2021-01-21

1. DELIVERY KIT

The delivery kit includes:

Transmitter	1 item;
Receiver	1 item;
Mounting kit	1 kit;
User manual, certificate	1 item.
Kit of tools and accessories	1 kit;

2. ACCEPTANCE CERTIFICATE

The sensor “Forteza FMC 10” _____ № _____ meets performance specifications of the Description Manual & Service Instruction No. 2021-01-21 and it is considered as operable.

Date of issue _____

1. MANUFACTURER’S GUARANTEES

The manufacturer guarantees the conformity of the sensor specifications to requirements of the Description Manual & Service Instruction No. 2021-01-21

if a user meets the service conditions and operating rules specified by the Description Manual & Service Instruction No. 2021-01-21

Warranty period is 24 months since the date of sale by the manufacturer.

Guarantees do not cover the sensors:

- with broken guarantee stamps;
- with mechanical failures,
- and also those which are out of order because of natural disasters (lightning, fire and flood).

Mean lifetime is 8 years.

CONTACTS

JCS “Forteza”

📍 2 Silutes pl. ofc 525, LT-91111, Klaipeda, Lithuania

☎ +370 46 441195 ✉ forteza@forteza.com